

BOLLY® 1 ST FB - WITH ALIGNED FRONT / BACK CONNECTIONS

POLYWARM® COATED DOMESTIC HOT WATER CALORIFIER WITH 1 FIXED HEAT EXCHANGER



APPLICATION

Production and storage of domestic hot water (DHW). All the connections are aligned on the front and on the back for quick and easy installation.

MATERIAL

Mild steel Polywarm® coated (Attestation ACS - SSICA - EN 16421 - WRAS)

HEAT EXCHANGER

Mild steel Polywarm® coated heat exchanger.

INSULATION

HARD: High thermal insulation with ecological polyurethane hard foam.
SOFT: NOFIRE® polyester fleece 100% made of recyclable material, with high thermal insulation. Fire resistance class B-s2d0 according to EN 13501. Grey PVC external lining.

CATHODE PROTECTION

Magnesium anode.

DRAIN

External confluence through drain connection. Models > 500 external confluence through drain connection.

GASKET- FLANGE PLATE

Silicone gaskets suitable for water intended for human consumption (tested according to 98/83/CE), max temperature up to 200°C. Mild steel inspection flange plate with Polywarm®.

WARRANTY

5 years (See general sales conditions and warranty)

ACCESSORIES AND SPARE PARTS

See Accessories section for the entire list.

NEW

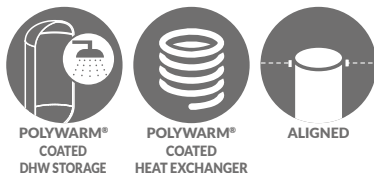

STOCK
AVAILABILITY

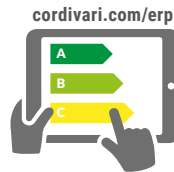

On line ErP label tool



BOLLY® 1 ST FB WB

HARD FOAM INSULATION

Model	Art. Nr.	Price €	HEAT EXCHANGER SURFACE [m²]	ENERGY EFFICIENCY CLASS
150	3104162330041	904,00	0,6	B
200	3104162330042	975,00	0,8	B
300	3104162330043	1.174,00	1,2	B
400	3104162330044	1.496,00	1,5	C
500	3104162330045	1.689,00	1,8	C
800	3104162330046	2.587,00	2,7	B
1000	3104162330047	3.070,00	3,5	B
1500	3104162330048	4.965,00	3,8	C



BOLLY® 1 ST FB WC

DISMOUNTABLE SOFT FLEECE insulation

Model	Art. Nr.	Price €	HEAT EXCHANGER SURFACE [m²]	ENERGY EFFICIENCY CLASS
800	3103162321162	2.373,00	2,7	C
1000	3103162321163	2.757,00	3,5	C
1500	3103162321164	4.531,00	3,8	C

ACCESSORIES

ELECTRIC IMMERSION HEATERS

Mod.	Heated volume by electric immersion heater [l]	MONOPHASE		
		1,5 kW	2 kW	3 kW
150	30	53	40	27
200	56	100	75	50
300	89	159	119	79
400	137	245	184	123
500	152	272	204	136
800	279	500	375	250
1000	345	618	464	309
1500	510	914	686	457

THREEPHASE				
4 kW	5 kW	6 kW	9 kW	12 kW
20	//	//	//	//
38	//	//	//	//
60	48	//	//	//
92	74	//	//	//
102	82	68	//	//
187	150	125	83	62
232	185	155	103	77
343	274	229	152	114

Electric immersion heater flange plate

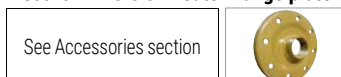

See Accessories section

Titanium electronic anode

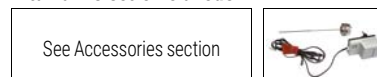

See Accessories section

Thermometer



Art. Nr.	€
5032240000107	107,00
5 units box	

BOLLY® 1 ST FB - WITH ALIGNED FRONT / BACK CONNECTIONS

POLYWARM® COATED DOMESTIC HOT WATER CALORIFIER WITH 1 FIXED HEAT EXCHANGER

Model	STORAGE		HEAT EXCHANGER	
	Pmax	Tmax	Pmax	Tmax
150 ÷ 800	10 bar	90 °C	12 bar	110 °C
1000 ÷ 1500	8 bar			



CORDIVARI® Lab

TÜV Rheinland Energie und Umwelt GmbH states that test procedures and Cordivari LAB are certified conforming to European standard EN 15332, as indicated by Ecodesign ErP Directive.

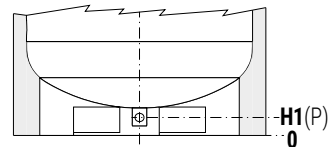
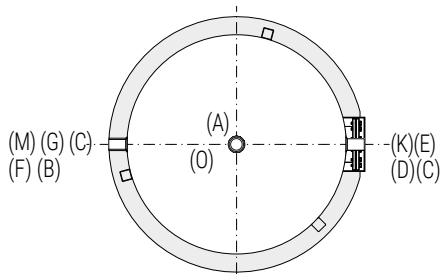
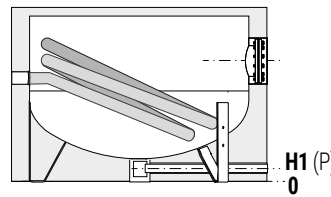
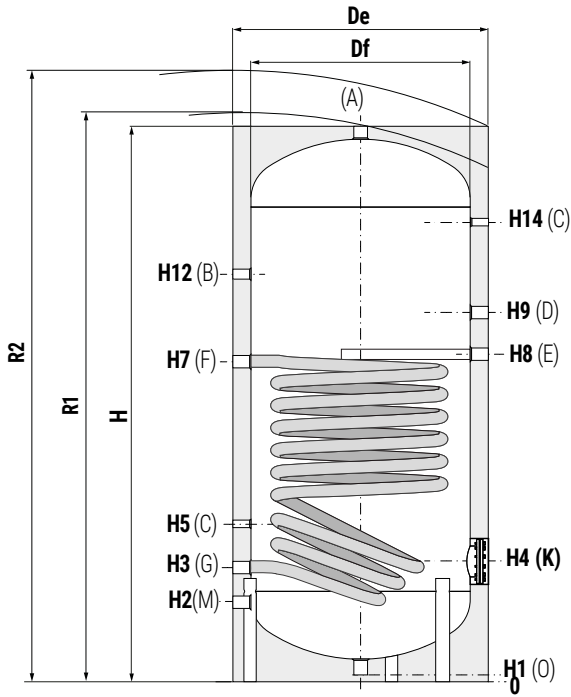
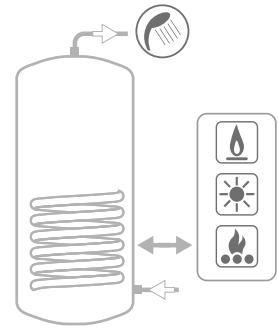

A	Domestic hot water outlet
B	Recirculation
C	Connection for instrumentation 1/2" G F
D	Connection for electric immersion heater
E	Connection for magnesium anode 1" 1/4 G F
F	Lower heat exchanger inlet 1" 1/4 G F
G	Lower heat exchanger outlet 1" 1/4 G F
K	Flange for inspection
M	Domestic cold water circuit inlet
O	Drain 1" 1/4 F - For models ≤ 500
P	Drain - For models > 500

Models from 1500 to 5000 are equipped with a practical **skirt** support which facilitate the handling with transpallets and forklifts. Also, discharge piping already mounted to allow **total emptying**.

BOLLY® 1 ST FB WB - HARD FOAM INSULATION

Model	Volume Weight		De	H	R2	H1	H2	H3	H4	H5	H7	H8	H9	H12	H14	K	P	M	D	B	A
	[t]	[kg]																			
			[mm]																		
150	148	49	500	1414	1505	71	210	275	315	395	888	956	1086	1065	1185	Øi120/Øe180	-	3/4"	1" 1/2"	3/4"	1" 1/4"
200	189	55	550	1434	1540	71	220	285	325	405	811	855	985	1089	1195	Øi120/Øe180	-	3/4"	1" 1/2"	3/4"	1" 1/4"
300	291	67	650	1486	1630	71	246	311	381	431	832	871	1006	1101	1221	Øi120/Øe180	-	1"	1" 1/2"	1"	1" 1/4"
400	422	88	700	1766	1905	71	261	326	396	446	988	1033	1170	1286	1486	Øi120/Øe180	-	1"	1" 1/2"	1"	1" 1/4"
500	498	120	750	1786	1945	71	271	346	411	466	1036	1076	1211	1331	1476	Øi120/Øe180	-	1"	1" 1/2"	1"	1" 1/4"
800	789	184	900	2162	2350	101	338	428	483	548	1181	1243	1378	1598	1788	Øi170/Øe240	3/4"	1"	2"	1"	1" 1/4"
1000	1038	215	1000	2217	2440	89	359	439	499	559	1279	1309	1444	1584	1819	Øi170/Øe240	3/4"	1" 1/4"	2"	1"	1" 1/2"
1500	1443	389	1100	2415	2660	109	340	425	575	545	1403	1450	1585	1825	2065	Øi300/Øe380	1"	1" 1/2"	2"	1"	2"

BOLLY® 1 ST FB WC - DISMOUNTABLE SOFT FLEECE INSULATION

Model	Volume Weight		DF	DE	H	R1	R2	H1	H2	H3	H4	H5	H7	H8	H9	H12	H14	K	P	M	D	B	A
	[t]	[kg]																					
			[mm]																				
800	789	184	750	950	2158	2194	2365	101	493	428	483	368	1181	1243	1378	1598	1788	Øi170/Øe240	3/4"	1"	2"	1"	1" 1/4"
1000	1038	215	850	1050	2192	2258	2435	89	524	439	499	389	1279	1309	1444	1584	1819	Øi170/Øe240	3/4"	1" 1/4"	2"	1"	1" 1/2"
1500	1443	389	950	1150	2440	2483	2705	109	450	425	575	375	1403	1450	1585	1825	2065	Øi300/Øe380	1"	1" 1/2"	2"	1"	2"

BOLLY® 1 ST / 1 ST FB

HEAT EXCHANGERS TECHNICAL DATA



Data have been calculated on following basis:

- 1) Primary circuit at T1 and proper energy source;
- 2) Production of DHW in continuous from 10 °C to t2;
- 3) DHW that can be taken in the first 10' and in the first hour from storage at 60°C, input 10°C and output 45°C;
- 4) Sanitary water according to UNI CTI 8065.

LOWER
HEAT EXCHANGER

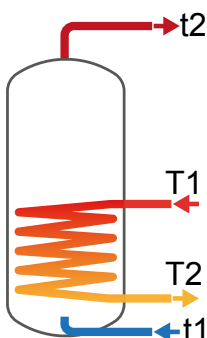

Model	Primary Flow rate [m³/h]	Ignition time (minutes) from 10 °C to t2 and primary at T1				Maximum power exchange (kW) with primary at T1, secondary within 10-45 °C and constant use of DHW production				DHW continuous production lt/h within 10-45 °C and primary at T1			
		T1/t2				T1				T1			
		55/50	65/60	70/60	80/60	55	65	70	80	55	65	70	80
150	2	99	102	71	46	6,6	10	11,7	15,2	162	246	288	371
	1	111	116	81	53	6,1	9,1	10,6	13,2	149	223	260	336
200	2,5	92	95	66	43	9	13,5	15,8	20,5	220	332	389	506
	1,25	103	107	75	49	8,3	12,3	14,4	18,5	203	303	354	456
300	3	97	101	70	45	13,5	20,2	23,6	30,6	331	498	583	756
	1,5	106	111	78	51	12,5	18,5	21,5	27,5	307	455	529	680
400	3,5	105	110	76	50	16,9	25,4	29,6	38,3	416	625	731	947
	1,75	117	122	86	57	15,4	23,2	26,9	34,5	387	571	664	853
500	3,5	111	116	81	53	20,2	30,1	35,1	45,3	496	742	867	1121
	1,75	126	131	93	61	18,7	27,3	31,7	40,6	459	674	782	1000
800	6	116	120	84	55	30,3	45,4	53	68,6	746	1120	1309	1695
	3	131	136	96	64	28,2	41,4	48,1	61,6	692	1021	1186	1521
1000	6	114	119	84	56	38,9	57,9	67,5	87	958	1429	1667	2151
	3	132	138	98	65	35,5	52,2	60,4	77	882	1288	1492	1903
1500	6	162	168	119	78	41	61	71	91,5	1009	1504	1753	2261
	3	189	197	139	92	37,7	54,9	63,4	80,7	927	1352	1564	1993

Model	Primary Flow rate [m³/h]	DHW produced in the first 10 minutes in lt/10' input 10 °C output 45 °C, storage at t2 and primary at T1				DHW produced in the first hour in lt/60' input 10 °C output 45 °C, storage at t2 and primary at T1				Heat exchanger pressure drop	
		T1/t2				T1/t2				[mm.c.a.]	[mbar]
		55/50	65/60	70/60	80/60	55/50	65/60	70/60	80/60		
150	2	195	251	258	272	298	407	440	507	218,85	21,46
	1	193	247	253	266	287	388	418	479	60,62	5,95
200	2,5	253	325	335	354	392	536	581	675	441,12	43,26
	1,25	250	321	329	346	378	512	553	635	122,19	11,98
300	3	388	499	513	542	597	814	882	1021	927,45	90,95
	1,5	384	492	504	529	578	780	839	960	256,91	25,19
400	3,5	550	706	723	759	814	1101	1186	1359	1480,67	145,20
	1,75	546	697	712	744	791	1058	1133	1284	410,16	40,22
500	3,5	651	834	855	897	965	1304	1404	1607	1850,84	181,50
	1,75	645	822	840	877	935	1249	1336	1510	512,70	50,28
800	6	1026	1314	1345	1410	1499	2023	2174	2483	1538,50	150,87
	3	1017	1297	1325	1381	1455	1944	2076	2344	426,18	41,79
1000	6	1345	1720	1759	1840	1952	2625	2815	3202	1994,35	195,58
	3	1332	1696	1730	1799	1891	2512	2675	3004	552,45	54,18
1500	6	1870	2378	2419	2504	2509	3330	3530	3936	2108,31	206,75
	3	1856	2352	2388	2459	2443	3209	3378	3722	584,02	57,27

HEAT EXCHANGERS PRESSURE DROP

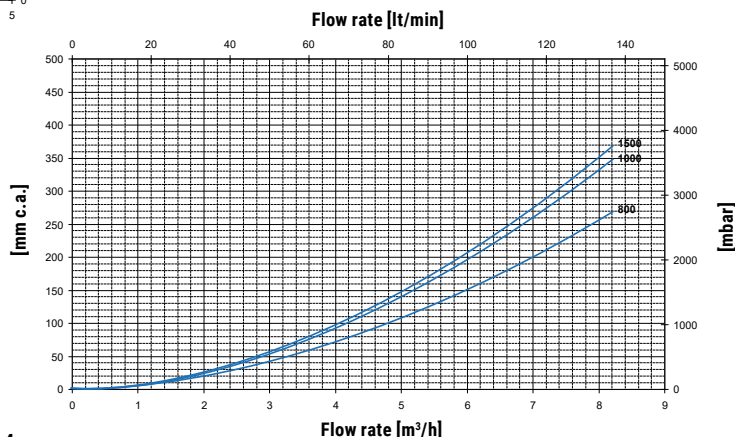
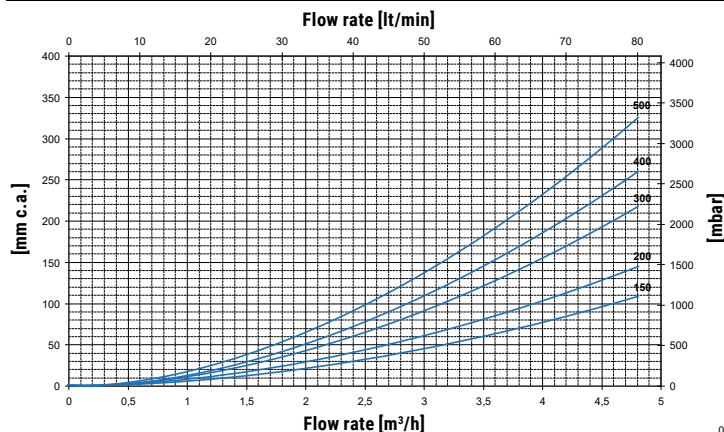

BOLLY® 1 ST / 1 ST FB

HEAT EXCHANGERS TECHNICAL DATA



Heat Exchanger output referred to temperature and flow rate of primary circuit and with secondary at 10/45°C at maximum withdrawal of producible DHW (Upper limit of the curves referred to maximum primary flow rate in the heat exchanger, while the lower limit in the curves refer to the minimum primary flow rate).

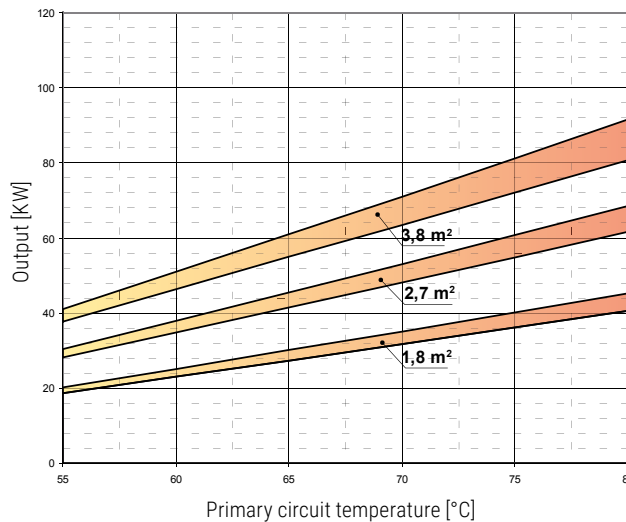
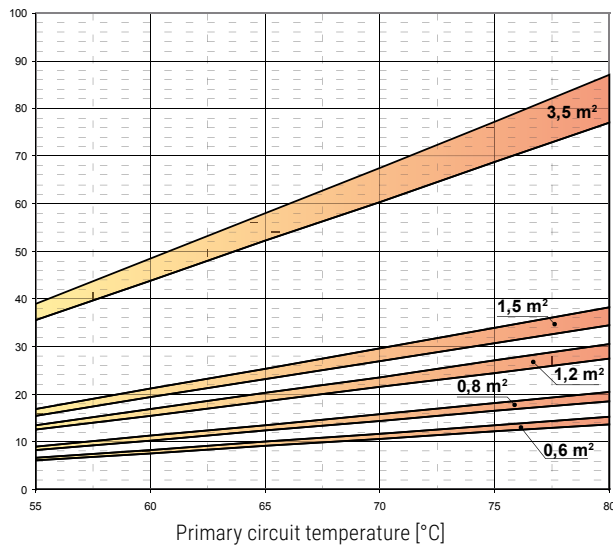

Heat exchanger surface	0,6 m ²		0,8 m ²		1,2 m ²		1,5 m ²		3,5 m ²	
	MAX	MIN	MAX	MIN	MAX	MIN	MAX	MIN	MAX	MIN
Flow rate [m ³ /h]	2	1	2,5	1,25	3	1,5	3,5	1,75	6	3

Heat exchanger surface	1,8 m ²		2,7 m ²		3,8 m ²	
	MAX	MIN	MAX	MIN	MAX	MIN
Flow rate [m ³ /h]	3,50	1,75	6	3	6	3

EXAMPLE OF INSTALLATION WITH BOLLY® 1 ST / 1 ST FB

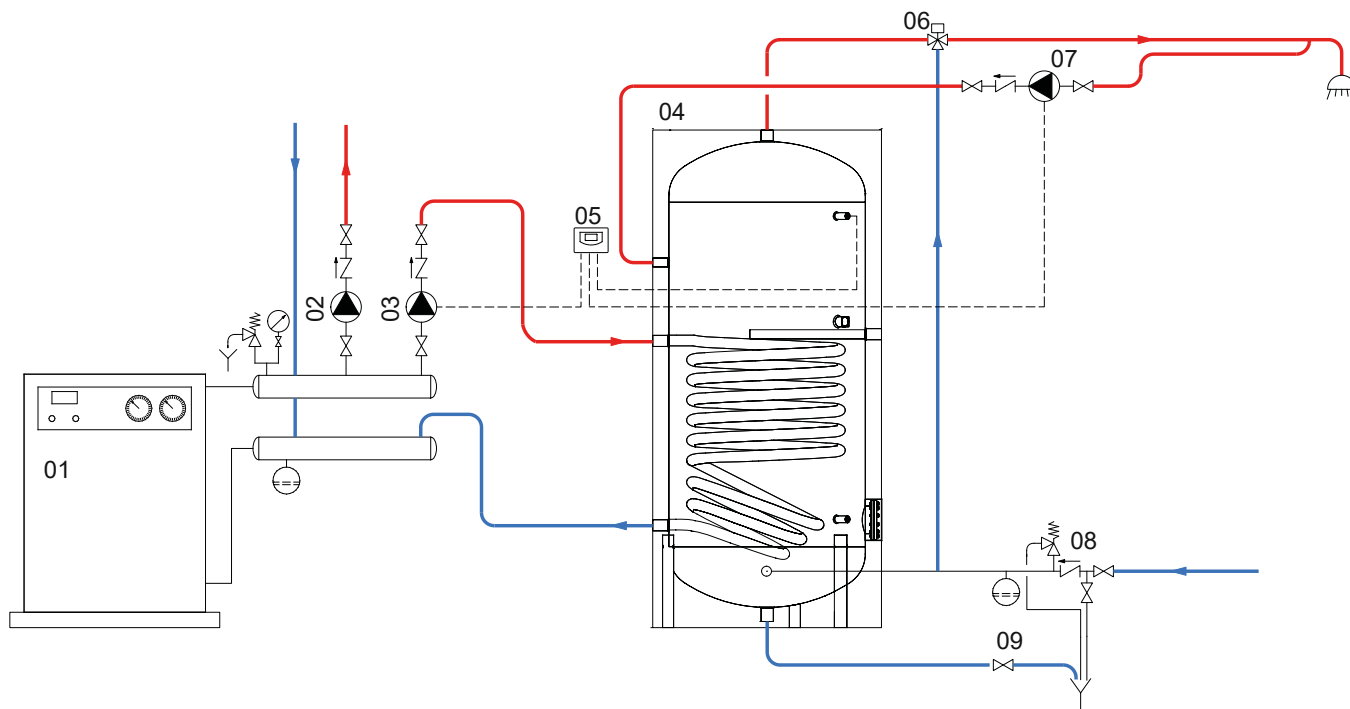

01	Generator	04	BOLLY® 1 ST / 1 ST FB	07	D.H.W. recirculation group
02	Heating system circulation group	05	Electronic control /thermostat	08	Hydraulic safety group
03	D.H.W. circulation group	06	Thermostatic mixing valve	09	Blowdown valve

The following schemes are purely illustrative. To realize the installation, always refer to a qualified technician.